

Varenummer: 201580M1050MT  
Beskrivelse: E+G Bolt GN 1580-M10-50-MT-H  
Hygiejnisk design

## Mål

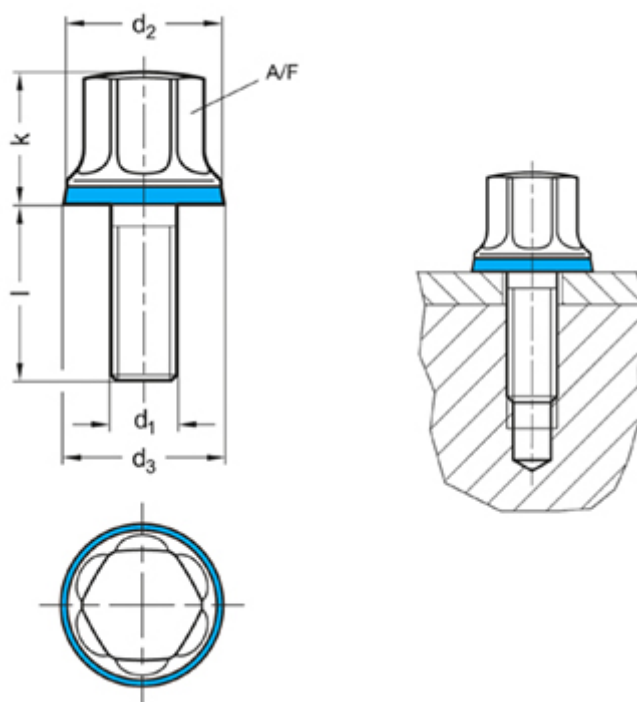

d1	= M 10
d2	= 21
d3	= 21.8
k	= 18
L	= 50
t min	= -
Vægt i (g)	= 55